



Dhyana 400BSI V3

995g Camera Weight **45w** Power Consumption

Better for sytemm optimization

100fps@4MP

For high speed lowlight imaging

Rolling Shutter Control Mode

For synchronize scanning



Typical Applications

- Low light imaging: STORM, PALM, SIM , etc.
- High speed imaging: Calcium, FRET, TIRF, high content, etc.
- Synchronize scanning : Light-sheet, spinning-disk confocal, spectroscopy, etc.

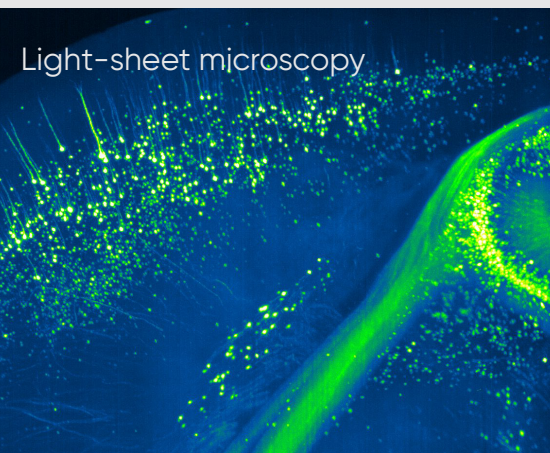

Light-sheet microscopy

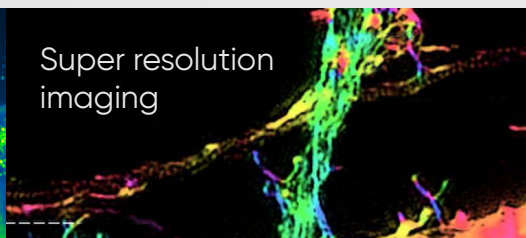

Super resolution imaging

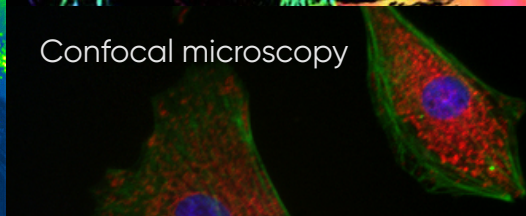

Confocal microscopy

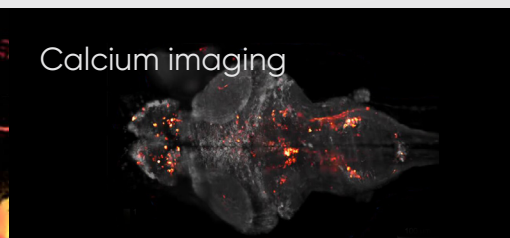

Calcium imaging

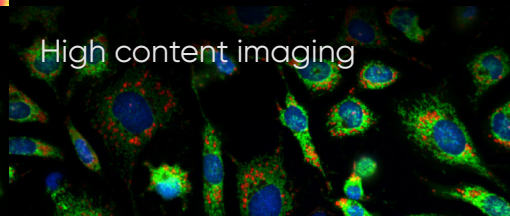

High content imaging

Technical Specification

Model	Dhyana 400BSI V3
Sensor Type	BSI sCMOS
Sensor Model	GSENSE2020BSI
Peak QE	95 % @ 600 nm
Color/Mono	Mono
Array Diagonal	18.8 mm
Effective Area	13.3 mm x 13.3 mm
Resolution	2048 (H) x 2048 (V)
Pixel Size	6.5 μm x 6.5 μm
Full-Well Capacity	Typ. : 45 ke-
Dynamic Range	Typ. : 90 dB
Frame Rate	HDR mode: 74 fps @ CameraLink, 40 fps @ USB3.0 HighSpeed mode: 100 fps @ CameraLink
Readout Noise	CMS: 1.1 e- (Median), 1.2 e- (RMS)
Shutter Type	Rolling, Global reset
Exposure Time	6.6 μs - 10 s
DSNU	0.2 e-
PRNU	0.3 %
Cooling Method	Air & Liquid
Max. Cooling Temperature	45 $^{\circ}\text{C}$ below ambient
Dark Current	Air: 0.5 e-/p/s @ -15 $^{\circ}\text{C}$ Liquid: 0.2 e-/p/s @ -25 $^{\circ}\text{C}$
Binning	2 x 2, 4 x 4
ROI	Support
Trigger Mode	Hardware & Software
Output Trigger Signals	Exposure start, Global, Readout end, High level, Low level
Trigger Interface	SMA
Data Interface	USB3.0 & CameraLink
Bit Depth	16 bit
Optical Interface	C-mount
Power Supply	12 V / 8 A
Power Consumption	45 W
Dimensions	85 mm x 85 mm x 127 mm
Weight	995 g
Software	Mosaic, LabVIEW, Matlab, Micromanager
SDK	C, C++, C#
Operating System	Windows, Linux
Operating Environment	Temperature 0~40 $^{\circ}\text{C}$, Humidity 10~85 %

Quantum Efficiency

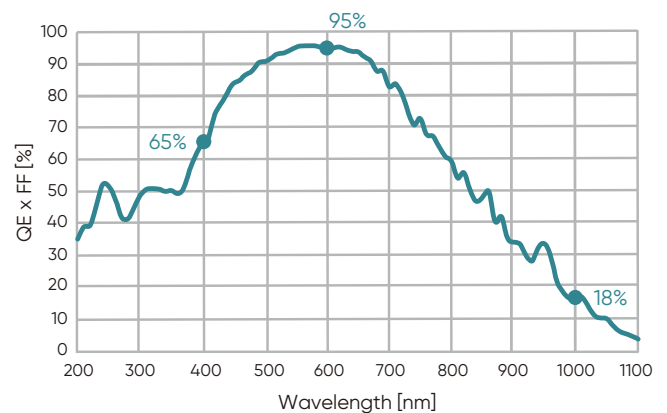

Dimensions (Unit: mm)

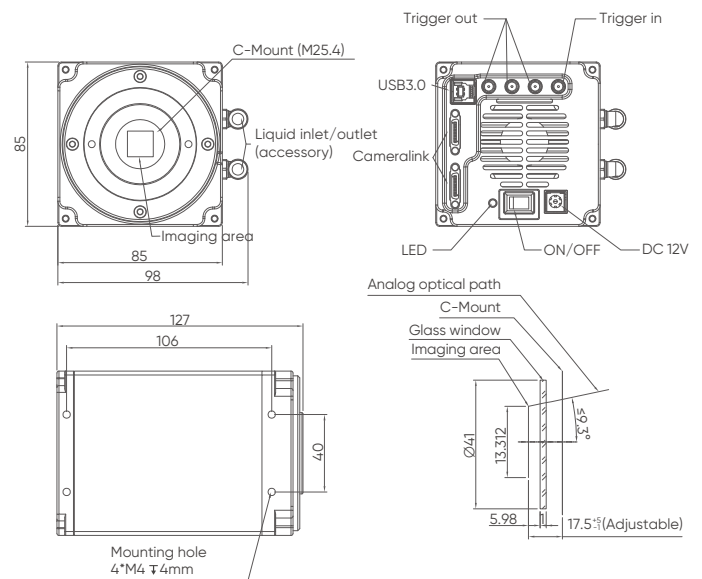

Contact Us

Tucsen Photonics Co., Ltd.

Website: www.tucsen.com

Email: support@tucsen.com

Tel: + 86-591-28055080

Address: 5# Wanwushe Smart Industrial Park, No.2 Yangqi Branch Rd, Gaishan Town, Cangshan Area, Fuzhou, Fujian, PRC

Tucsen on Social Media

Keep in touch with us via the social networks:

